



MASSEY FERGUSON

270-400 HP

MF 8700



FROM MASSEY FERGUSON

Contents



Page 04
Shrink your workload



Page 06
The new dimension in farming power



Page 10
Smart design:
built to put power to the ground



Page 16
The smoothest power delivery,
the ultimate in productivity



Page 20
Experience a new dimension in
comfort and control



Page 28
OptiRide Plus: the ultimate cab
suspension system



Page 38
Fuse Technologies:
joined-up farming

- 03 Beauvais – Centre of Engineering and Manufacturing Excellence
- 04 Shrink your workload
- 06 The new dimension in farming power
- 08 BodyScan your MF 8700 !
- 10 Smart design: built to put power to the ground
- 12 SCR technology: silently saving you money
- 14 Engine power management: more muscle when you need it
- 16 The smoothest power delivery, the ultimate in productivity
- 18 The tractor transmission without limits
- 20 Experience a new dimension in comfort and control
- 22 New MF 8700 Dashboard - puts you in total control
- 24 Efficient package: advanced equipment for outstanding accuracy
- 26 Exclusive package: for those who demand more
- 28 OptiRide Plus: the ultimate cab suspension system
- 30 The new dimension in traction – Ultimate performance in all conditions
- 32 Best in class 400hp manoeuvrability
- 34 Powerful Hydraulic Muscle
- 36 Performing the most demanding operations with precision
- 38 Fuse Technologies: joined-up farming
- 40 The CCD console: keeping you informed and in control
- 42 Guidance options to keep you on track for profit
- 44 Your finger on the pulse at all times: Introducing AGCOMMAND™
- 46 Lifetime from Massey Ferguson: No matter where life or work takes you, we'll be there
- 48 No hidden costs: All-Inclusive service from Massey Ferguson
- 50 Servicing made easy – simple and straightforward
- 52 Standard and optional equipment – tailor your tractor to your needs
- 54 Specifications as standard
- 55 Dimensions



Beauvais, France | Centre of Engineering and Manufacturing Excellence



The €250m investment made over the last five years in the Beauvais tractor plant, home of Massey Ferguson's high range of tractors, has been carried out with a singular aim: to ensure Massey Ferguson tractors are built to standards of quality, reliability and productivity that guarantee peace of mind for the owners and operators who depend on them. More than 870,000 tractors have been built in Beauvais since it was opened in 1960, and farmers in over 140 countries rely on its products.

The 2500 staff employed at the Beauvais site take particular pride in the products they design and manufacture, and while as many as 90 tractors a day leave the line, each one is crafted with the utmost care and attention. That focus on quality is coupled with Massey Ferguson's reputation as a leader in developing and offering innovative and pioneering solutions with clear, measurable benefits, such as fuel-saving Selective Catalytic Reduction (SCR), which we were first to bring to the market. The result is tractors which help you farm more productively and more efficiently.

Continuous research and development into making machines that do more for those that own and operate them has been part of the reason Massey Ferguson has won more independent innovation awards than any other manufacturer. As farmers' needs continue to evolve, that R&D commitment remains as strong as ever.

400HP

Shrink your workload: the most powerful Massey Ferguson tractors ever built are now yours

The new MF 8700 series represents the pinnacle of Massey Ferguson's engineering achievements. It's topped by the most powerful tractor we've ever made, a flagship model that surpasses 400hp in a conventional design. But we haven't done that simply to make a statement. The groundbreaking new MF 8700 series offers some of the most efficient, effective and useable power in this category. If you're a current Massey Ferguson customer, take a closer look and you'll see what makes the MF 8700 even more productive than the machines you've come to know and trust. And if you're new to Massey Ferguson, we'd like to invite you to read on so that we can show you why the MF 8700 series is different to any other tractor range in this power bracket.

These are tractors with an enormous appetite for work, built to effortlessly cover hectare after hectare, all the while keeping the operator refreshed and the fuel bill to a minimum. While these are the largest tractors made by Massey Ferguson, the DNA that runs through all MF tractors is clearly evident, with design cues from the same solid, stylish mould. The same commitment to product quality that marks all MF products is also immediately apparent, with the MF 8700 sharing the same skilled engineering and manufacturing team and award-winning Beauvais, France factory. But our engineers recognise that, while characteristics such as quality, reliability and fuel efficiency are important to all tractor users, in this power category there are some very specific requirements – the ability to handle wide kit, long hours and difficult field conditions. MF 8700 tractors are designed to take this and more in their stride.

With five models in the range, spanning max powers of 300-400hp with engine power management, MF 8700 tractors can operate with ease the largest drills, tillage implements, tankers and trailers. All are equipped with the industry's leading CVT transmission, Massey Ferguson's Dyna-VT, for the ultimate in efficiency, to make this new dimension of power work for you.

THE 8700: CHAMPION OF THE FIELD





MF 8700



MF 8700

Farming practices in today's climate have many obstacles which farmers and contractors have to face. With the world's population rising, a greater demand for food and land with changeable and volatile weather conditions, you need machinery you can rely on.

We understand those new challenges and our engineers are at the forefront of tractor design and so our new range of flagship tractors has been designed and built by the people who truly understand the nature of your business. Through insight and innovation we built the MF 8700 to meet the needs of modern farming so you can look to the future with confidence.

The new dimension in farming power

	MF 8727	MF 8730	MF 8732	MF 8735	MF 8737
Max power @ 1900 rpm (hp)	270	295	320	350	370
Max power with EPM (hp)	300	325	350	380	400
Max torque @ 1500 rpm with EPM (Nm)	1,300	1,390	1,500	1,590	1,600
Cab versions	Efficient or Exclusive				

Already setting the benchmarks for the high-horsepower tractor sector, the MF 8700 models feature key components that have been optimised and enhanced over those of their predecessors to bring a new level of performance to the industry.

Highlights

- **New generation AGCO Power engines** provide levels of torque and horse-power unsurpassed in conventional tractor design, from the minimum of fuel. Coupled with the ultimate in transmission technology – the blend of efficiency, economy and ease of use that marks out Dyna-VT as the finest CVT in the business – these are tractors built to handle the heaviest loads and the hardest tasks.
- **A Best-in-Class operator environment** is nothing more than you would expect for a tractor of this type – and from Massey Ferguson in particular. Putting you in control of this power is a first class cabin offering state-of-the-art comfort and controls for full operating precision hour after hour.
- Massey Ferguson has long been a **leader in providing solutions to help farmers keep operating costs to a minimum**, and the MF 8700 tractors continue that legacy, incorporating the latest in AGCO Fuse Technologies™ to ensure operators and owners are kept informed and their machines are working at their optimum.
- All this is backed up by the **best customer service in the business**, designed to ensure that your machines are always operating at their optimum. Massey Ferguson dealers provide out-of-season servicing that fully prepares you for the year ahead, while in the event of a breakdown they will ensure your machine is up and running as soon as possible.

BodyScan your MF 8700 !

Live the 400hp experience to the fullest

Across the board, we have injected new thinking into the design and features of the MF 8700, to improve power, comfort, useability, efficiency and reliability.

01 NEW engine power outputs up to 400hp with EPM

The most powerful tractors ever made by Massey Ferguson, designed for the ultimate in output, with low running costs.

02 NEW exhaust redesigned to meet Tier 4 Final requirements

Helps meet forthcoming emissions legislation.

03 NEW improved cooling package

CYCLAIR system designed to match the prodigious power output produced by industry-leading 8.4 litre AGCO Power engines.

04 NEW front-end redesign for improved airflow

Carefully crafted to match the new cooling package.

05 NEW Panorama Cab

Available with 2 specifications packages. With plenty of room available, quietness and 360° visibility, the panorama cab comes with a new dashboard design and the new armrest including the Multipad lever on Exclusive versions.

06 NEW redesigned rear hitch

Stronger, more robust, easier to use, with higher capacity than ever before.

07 Wheel diameter

2.15 metre rear wheel diameter for better traction, reduced soil compaction, giving the maximized performance to the ground

08 NEW front monobloc weight installation

Made for quick and easy installation and removal as required.

09 Ultimate Dyna-VT Transmission

Dyna-VT transmission now comes with Engine Power Management to bring you extra power when you need more.

10 OptiRide Plus Cab Suspension

11 Superb rear linkage with extreme 12,000 kg lift capacity

12 Packed with straightforward onboard technologies

Auto-Guide™ 3000 auto-steering and AGCOMMAND™ telemetry options. Auto-Guide™ 3000 with Go Mode now fully available through the optional CCD Console.

13 Front linkage for maximum productivity in the field

A front linkage and PTO which are seamlessly integrated into the front end of the tractor, for full strength yet complete convenience, alongside the 4WD axle and optional front suspension – 5,000 kg massive lift capacity.

MF 8700



400HP

400 horsepower of pure torque and rugged capability. Built to last, it can tackle the toughest terrain and farm the largest areas of land for longer with low running costs and superb reliability. The MF 8700 Series is an accumulation of power, strength, superior engineering, cleaner, more fuel efficient engines.



MF 8700

Smart design: built to put power to the ground



Fuel consumption accounts for an important part of the running costs of a tractor, and minimising its use can have a significant effect on a business's bottom line, as well as helping to meet the industry's environmental commitments. How the driver operates a machine can have a significant bearing on its fuel use, and our engineers have done their utmost to help here. With 8.4 litres displacement from its six cylinders, plus third generation Selective Catalytic Reduction (SCR) technology, Exhaust Gas Recirculation (EGR) and a Diesel Oxidation Catalyst (DOC), the engine used in the MF 8700 series is not only one of the most productive powerplants available, but is also among the most fuel efficient on the market. Engine Power Management (EPM) now provides a 30hp power boost for PTO, hydraulic work and transport.

The DOC is concealed under the bonnet to retain the impressive visibility for which MF tractors in this power bracket are well-known. Like the exhaust, it's a maintenance-free unit, so there is no additional service requirement for the operator. Twin turbochargers with electronic wastegate control, between which is fitted an air/water intercooler to further improve fuel economy, are linked to the cooled EGR system to produce the best engine response across the engine speed range, ensuring sufficient power is always available – at low rpm as well as high. Optimised high pressure common rail fuel injection limits the emissions of Particulate Matter (PM) and means there is no need to fit a Diesel Particulate Filter (DPF).

At this amount of power, cooled EGR aids cooler running and cuts AdBlue and fuel consumption, while the DOC is tucked away neatly under the slim, sloping bonnet, while the narrow, oval-shaped exhaust stack also ensures vision is unimpeded.

Massey Ferguson was the industry innovator in SCR technology, and from the outset our tractors in this power bracket have been designed with this system and its complementary technologies at their heart. That's why there has been no need for radical design changes in

the MF 8700 development, allowing the retention of the slim, sloping bonnet design that makes for impressive all-round vision.

MF 8700 tractors also feature a new, higher capacity cooling package to further improve performance, although they retain the same slim bonnet and industry-leading forward visibility of their predecessors. With CYCLAIR, air is directed through a fuel cooler and then a Charge Air Cooler (CAC) where it increases speed through the intercooler. The pack also contains the water radiator, oil cooler and condenser. The bonnet vent arrangement splits the air flow to expel hot air, while directing cool, fresh air towards the main radiator. Filter and radiator access has been designed to make daily maintenance as simple as possible.

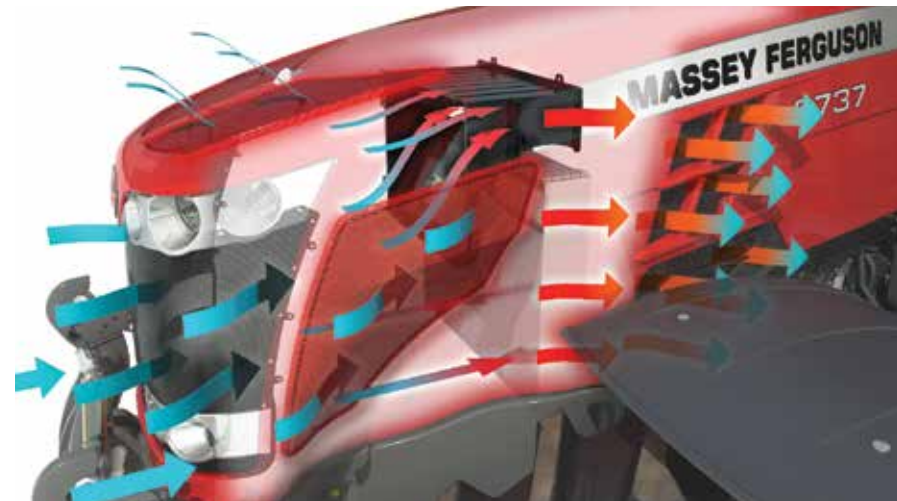



SCR technology: silently saving you money

Massey Ferguson pioneered the use of Selective Catalytic Reduction (SCR) technology for tractors. In conjunction with a diesel oxidation catalyst (DOC), the SCR system doesn't just benefit the environment through cleaner exhaust emissions. The combination of SCR and DOC, plus the addition of Diesel Exhaust Fluid (DEF/AdBlue®), makes for a more efficient engine.

Designed for high efficiency and low maintenance, the DOC is a flow-through device located under the bonnet, designed to oxidise harmful gases produced by diesel combustion into harmless compounds. DEF is injected into the DOC, vaporising in the exhaust gas stream, with hot exhaust gas then crossing the catalyser, where the heat of the gas causes its nitrous oxide content to react with the AdBlue® to produce ammonia. Carbon monoxide, gaseous hydrocarbons and particulate matter are oxidised, a pair of catalysts in the exhaust then change them into harmless nitrogen and water. Because the engine emissions are controlled externally, in the

exhaust gas system, there is no impact on engine performance, power production or fuel economy. Filling up with AdBlue® can be done when filling with fuel, and no further additional activity is required.

SCR is the simplest of systems, with AdBlue® contained within a separate tank adjacent to the fuel tank itself. Consumed at an average of 3-5% of AdBlue® to diesel, it needs replenishing only every second fuel tank fill.

Back in 2008, Massey Ferguson has pioneered SCR Technology and this is now the industry standard. But we are still leading the way !

The only impact on your business is a positive one – on your fuel bills.

Highlights

Engine Highlights:

- AGCO POWER 6 cylinder, 8.4 litre engines generate maximum power from 290 hp up to 400 hp with EPM
- Maintenance free, 3rd Generation Selective Catalytic Reduction (SCR) Technology
- External EGR for improved fuel economy and AdBlue® consumption
- Electronically controlled common rail fuel injection
- Twin turbocharger installation for higher power capacities and best engine response at all engine revs
- Efficient and smartly designed cooling package with CYCLAIR System.



Selective Catalytic Reduction (SCR)

Selective Catalytic Reduction (SCR) process with the Diesel Oxidation Catalyser (DOC)

- 01** The exhaust gases leave the turbocharger and enter the DOC cylinder.
- 02** The exhaust gases go through the Diesel Oxidation Catalyst (yellow). Carbon Monoxide (CO), Gaseous Hydrocarbons (HC) and Particulate Matter (PM) are neutralised here. Nitrogen oxides are prepared to react with the urea.
- 03** Carefully controlled injection of AdBlue® occurs.
- 04** The gases that have mixed with the AdBlue® leave the DOC cylinder to reach the exhaust pipe which contains the catalyst.
- 05** As the gases pass through the catalyst, the NO^x is converted into harmless nitrogen and water.
- 06** Clean air and water vapour leave the exhaust pipe.

Engine Power Management:

more muscle when you need it

Imagine a tractor that responds automatically to the load imposed on it, and adjusts fuelling accordingly to give you extra power when you need it most. MF 8700 tractors benefit from Engine Power Management, providing a power boost designed to tackle tough transport and PTO work. Advanced electronic engine and transmission management make more power automatically available under load or at speed.

EPM works by way of transmission electronics which monitor the load and operating conditions within the transmission, PTO and hydraulics according to forward speed, transmission load and PTO activation. This information is then communicated to the electronic engine management system, which then regulates accordingly the quantity and timing of fuel required.

EPM makes up to an additional 30hp available. On transport application extra power engages from 15 km/h and become fully available at 22km/h and above.

On PTO or Hydraulic work, extra power automatically becomes available above 0,1 km/h

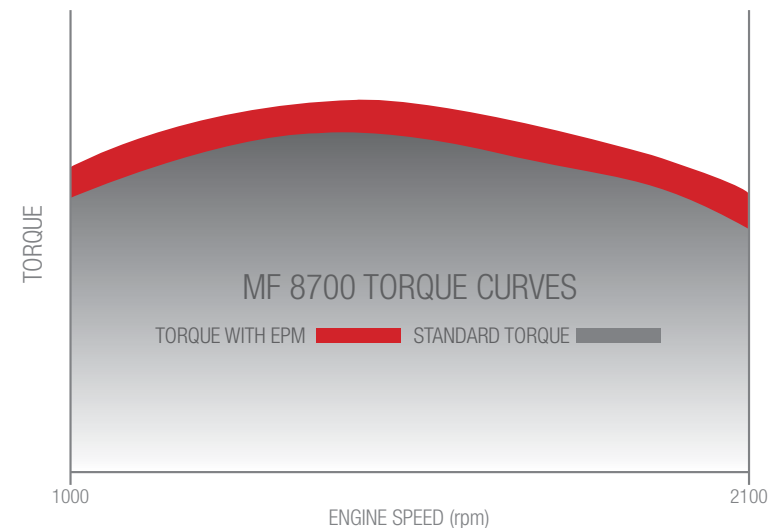
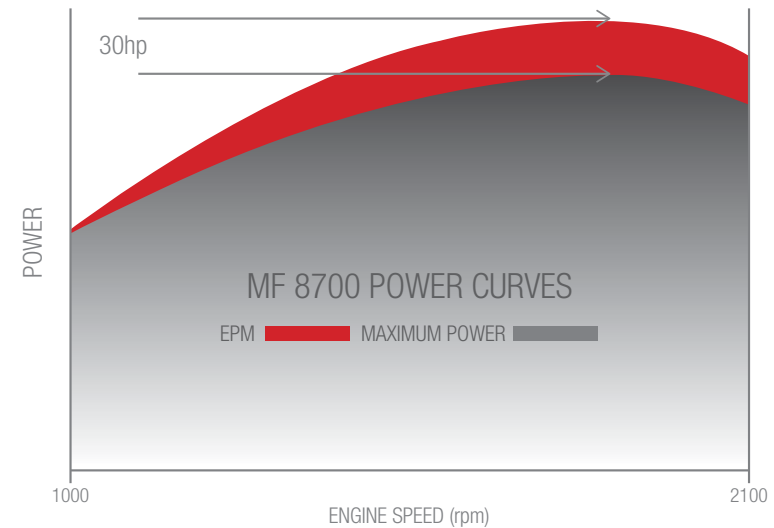



Dyna-VT The smoothest power delivery, the ultimate in productivity



MF 8700 With the continuously-variable Dyna-VT transmission, we have developed a system of power transfer that surpasses all others for ease of use and efficiency. We have taken a proven, refined transmission and made it even better, ensuring it delivers seamless strength hour after hour. It's intuitive to the operator, the easiest of transmissions to understand and get the most from, and new operators will quickly settle into feeling at one with the tractor.

MF 8700

Dynamic performance whatever the application. Massey Ferguson's Dyna-VT transmission provides enhanced productivity in stepless precision.



Once you have selected the mode in which you wish to drive the tractor – via the foot pedal, with the armrest lever or even with the Power Control lever – you can then focus on the work. Forward and reverse speeds and rate of acceleration can be pre-set and are maintained automatically, and stored in the tractor memory after shutdown for later use, making any operation requiring regular shuttling far less tiring.



Multipad Joystick

The Command Control armrest, and the Multipad joystick - standard on MF 8700 Exclusive tractors - are part of the package that makes these tractors, despite their power, so easy to control with precision. A multitude of functions can be controlled in the palm of your hand.

Stepless precision Dyna-VT offers stepless travel from 0.03 to 40 or 50 km/h* at any engine speed, operated via two speed ranges. This means it is always possible to achieve the correct operating speed for the conditions and for the implement being used, and it is always possible to achieve the optimum engine speed to maximise work rate and minimise fuel consumption. Engine speed and forward speed are independent of each other, and forward speed can be instantaneously increased or decreased under full load to maximise output and maximise work quality.



Cruise Control and Supervisor

MF 8700 tractors are fitted with an engine speed 'Supervisor' which automatically reduces forward speed to maintain full engine power by maintaining engine speed, whatever the job in hand. In conjunction with the ability to store two speed settings, this means the tractor is always working at its optimum.

Depending on the tractor type specified, Dyna-VT can be operated via either a T-bar controller or the Multipad joystick on the right-hand armrest. Speed variation is also possible through the steering column-mounted PowerShuttle lever.



Simple, multi-function Power Control

The Power Control lever provides convenient three-in-one, straightforward operation. Operators can shuttle between forward/reverse, select neutral, leaving the right hand free to operate the rear linkage or implement hydraulics.

*depending on market legislation.



Dyna-VT

The tractor transmission without limits

Highlights

Dyna-VT Highlights:

- 0.03 to 40 km/h or 50 km/h*
- 40 km/h super Eco or 50 km/h* Eco
- The choice of two speed ranges optimises torque for different applications
- Lever, pedal or automatic control
- C1/C2 cruise speeds
- 'Supervisor' maximises the output under varying loads
- Dynamic Tractor Management (DTM) maintains the set travel speed by automatically adjusting the power (engine speed) according to load
- Active Stop
- Turbo clutch on/off
- Shuttle aggressiveness adjustment
- Pedal aggressiveness adjustment
- Switch between cruise speeds (C1 and C2)
- Brake pedal to neutral feature

*Depending on market legislation

MF 8700

The original Dyna-VT transmission is a true testament to precision engineering; guaranteed productivity, complete operator comfort and optimum fuel efficiency at all times. Further, consistent enhancements such as Dynamic Tractor Management (DTM) make it the most intuitive transmission on the market.

Stepless precision

Dyna-VT is amazingly simple to operate and works extremely well in differing conditions. There's no shifting of gears, no jolts and no breaks in traction or power. The unique Power Control lever makes forward/reverse shuttling and speed change convenient and hassle-free.

Dynamic Tractor management

When activated, Dynamic Tractor Management (DTM) works in conjunction with the Dyna-VT transmission, in either level or pedal mode, to automatically control engine speed according to the load on the tractor, maintaining the required forward speed whilst keeping rpm to the minimum necessary. It works from 1000-2100 rpm, with the operator able to set both a lower and an upper limit within the range. DTM can be activated with trigger such as PTO, Linkage or hydraulic activation. The result is smoother driving and excellent fuel efficiency.

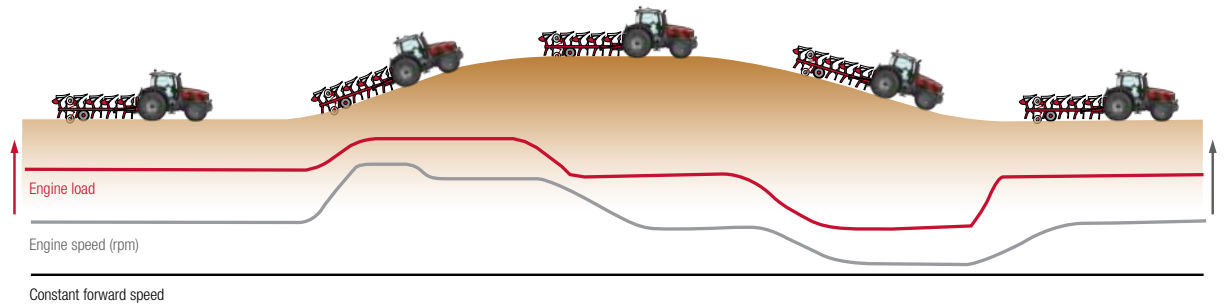

▲ Dynamic Tractor Management (DTM): As the load (red line) varies according to the conditions, the Dyna-VT will automatically adjust the engine speed (grey line) to maintain the forward speed whilst minimising fuel consumption and noise levels.

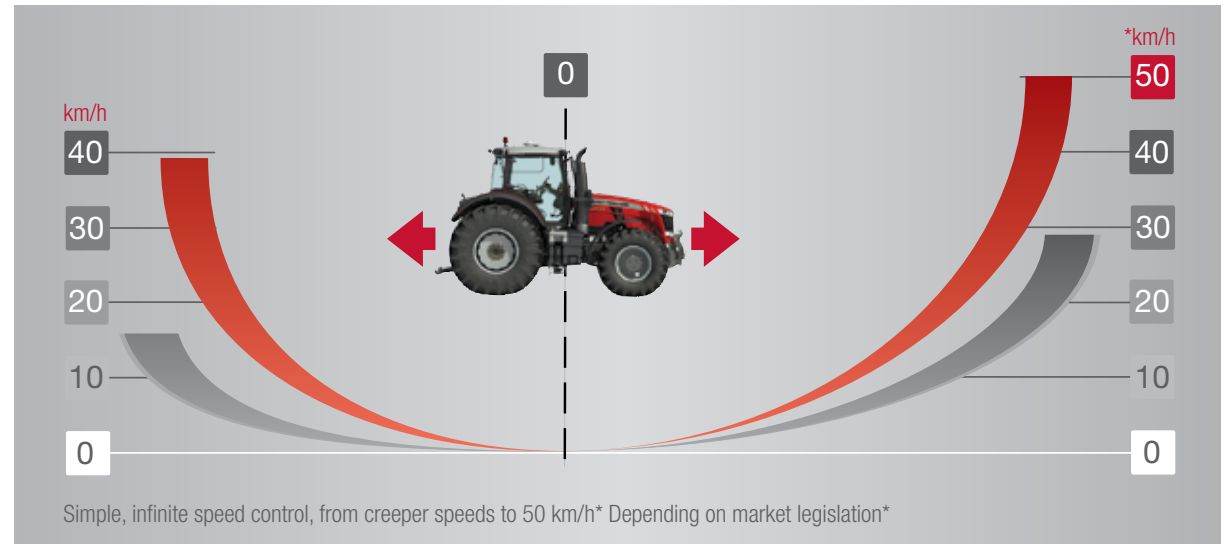

Experience a new dimension in comfort and control

Beneath their dramatic exterior, and despite their enormous power, the cab of each MF 8700 series tractor provides a working environment that blends comfort, quietness and high quality from which to control the machine. This impeccably-crafted cabin incorporates smart design and best-in-class ergonomics for hours of fatigue-free operation as you should expect from Massey Ferguson.

Efficient or Exclusive – the freedom to choose your own working environment

The MF 8700 range is available in two specification levels: Efficient and Exclusive, for a choice of premium or super-premium environments and specifications. Both are designed around a spacious frame and logical, carefully thought-out controls. Everything is to hand, with key controls all on the operator's right, and those used most often grouped on the armrest. Compromise isn't necessary – our aim is simply to help you make a personal choice to match your business requirements and objectives.

Best-in-class design

The four-pillar cab frame design makes for superb 360° all-round vision to the sides and out to the extremities of wide implements, while the award-winning OptiRide Plus cab suspension uses cutting edge sensors, hydraulics and accumulators to ensure the operator is always on the level. The level of damping can be set in from the cab, to meet the driver's preference. Paired with a premium-class air-suspended operator's seat, the result is one of the most comfortable rides around.

Intuitive ergonomics

Accessed via broad steps and a single, wide, full-glass door, there's plenty of space in the cab for the driver, a passenger and anything required for a long day's work. Once the door is closed and the engine started, you'll notice just how quiet this cab is. Almost everything you need to control the tractor's key functions is grouped on the right-hand armrest, arranged so that operation is almost immediately intuitive.

New Dashboard with SIS – Setup and Information Screen

A completely new, slim dashboard design provides for quick, clear and easy analysis of operating data, presented on 70 mm x 52 mm colour screen for the SIS. Not only is the new screen 50% larger than before, but it has a resolution ten times better and large graphics that make information easy to read in all light levels.



Intuitive controls

On the right hand side pillar, a new control layout follows the familiar Massey Ferguson style, incorporating modules to operate the lights, PTO speed selection and rear linkage settings.



Little extras make a big difference

Sometimes it's the small details that can make a huge change to your workload. The MF 8700 cab is available with numerous comfort and convenience features, Automatic beacon activation on road, Comfort light delay at end of the day with automatic work lights extinction, extra plug sockets for mobile phones or laptop, radio and CD player (including MP3), air suspended swivel seat, telescopic side mirrors and electric de-icing, plus automatic air conditioning.





MF8700

New MF 8700 Dashboard: puts you in total control

The new slim dashboard design provides a quick, clear and easy analysis of operating data, presented on the new 70 x 52 mm Setup and Information Screen (SIS). Not only is the new screen 50% larger than before, but it has a resolution ten times better and large graphics that make information easy to read in all light conditions.

The new dashboard also provides outstanding front visibility thanks to its slim design.



New intuitive navigation and control with easy access of the SIS through the steering column mounted pad



Should you need more control, choose the Datatronic 4 CCD console (optional on Efficient version and standard on Exclusive) – find more details on page p.40.



Highlights

The Setup and Information Screen includes:

Setup:

- Transmission operation
- Slip control
- Engine speed control
- Hydraulic valve flow and timing
- Easy-to-use headland management
- Front loader control
- PTO activation via rear fender switch
- Comfort light delay
- Trigger for counting mode
- Display setting

Information:

- Tractor performance
- Working area
- Working/travelling distance
- Fuel and urea consumption
- Engine and transmission temperature
- Slippage measurement



MF 8700

Efficient Package:

advanced equipment for outstanding accuracy



Efficient is the entry specification package for the MF 8700 series but you will notice that it is anything but basic. Dedicated to delivering increased productivity thanks to key features, the Efficient specification will enable the operator to work really fast, to a higher standard, with more accuracy together with high levels of comfort, ergonomics and reliability. It provides all the key elements with a blend of simplicity and ease of use, with all key functions ergonomically grouped in the Control Command Centre armrest.

Standard Efficient features includes:

- Command Control Armrest with « T » lever
- Power Control Shuttle lever
- Automatic Air Suspended Swivel Seat
- “QuadLink” suspended front axle
- Standard air conditioning
- 4 electronic spool valve with joystick and fingertip control

Efficient specification option:

- OptiRide Plus semi-active cab suspension
- Super Deluxe Air Suspended Seat
- Automatic air conditioning
- Datatronic 4 CCD
- Radar & slip control
- Integrated front linkage and front PTO
- SpeedSteer
- Auto-Guide™ 3000 with Go mode
- AGCOMMAND™ Telemetry system
- Mirrors with electric de-icing and adjustment
- 1000 Eco PTO

Work lights
and beacon
control panel

Electronic
rear linkage
adjustment



MF 8700



- Fingertip spool valve controls
- Engine speed memo A & B
- Transmission control lever
- Road / field transmission mode
- C1 / C2 cruise speed controls
- Rear linkage controls
- Hand throttle
- Joystick spool valve control with assignment switches function
- Front hydraulic controls assignment
Hydraulic activation
- Linkage depth control
- Fingertip spool valve control
- PTO engagement
- Lever or pedal mode selection
- C1 / C2 cruise speed setting
- Dynamic Transmission Management engagement

Exclusive Package:

for those who demand more



You'll always find the usual necessities within our cabs but we always strive to push operator comfort and control to the next level. That's why the Exclusive package comes with dramatic new features that will help to improve further your working day.

The Exclusive MF 8700 Package is dedicated to the more intense, large scale operator looking for more advanced features that will ensure cost effective benefits for their business.

Standard Exclusive features includes:

- Command Control Armrest with MultiPad lever
- Power Control Shuttle
- "QuadLink" suspended front axle
- Automatic air conditioning
- OptiRide Plus semi-active cab suspension
- Super Deluxe Air Suspended Seat
- Mirrors with electric de-icing and adjustment
- Datatronic 4 CCD
- Radar & slip control
- Integrated front linkage
- SpeedSteer
- Auto-Guide™ 3000 with Go mode
- AGCOMMAND™ Telemetry system
- 4 electronic spool valve with joystick and fingertip control

Exclusive specification option:

- 2 additional rear remote valves
- Integrated front PTO
- 2 sets of hydraulic front couplers and free hydraulic return
- 1000Eco PTO



Work lights
and beacon
control panel

Electronic
rear linkage
adjustment

Datatronic Control Centre Display
 The 7" Datatronic Control Centre Display screen is sited within easy reach and sight of the driver, and is fully adjustable according to operator preference to allow optimum viewing of all tractor functions.

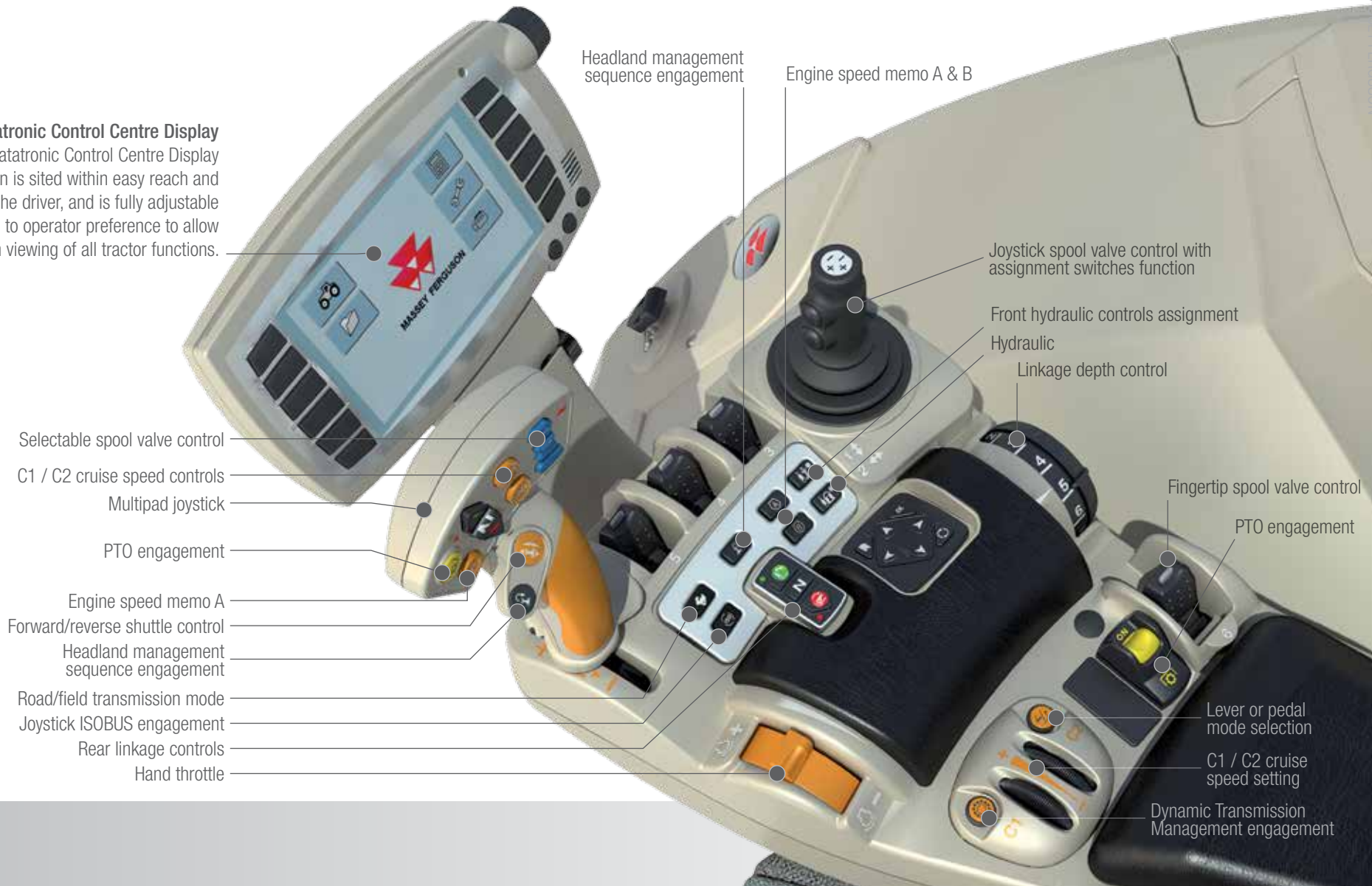

Headland management sequence engagement

Engine speed memo A & B

Joystick spool valve control with assignment switches function

Front hydraulic controls assignment

Hydraulic

Linkage depth control

Fingertip spool valve control

PTO engagement

Lever or pedal mode selection

C1 / C2 cruise speed setting

Dynamic Transmission Management engagement

Selectable spool valve control

C1 / C2 cruise speed controls

Multipad joystick

PTO engagement

Engine speed memo A

Forward/reverse shuttle control

Headland management sequence engagement

Road/field transmission mode

Joystick ISOBUS engagement

Rear linkage controls

Hand throttle

OptiRide Plus:

the ultimate cab suspension system

A comfortable operator is a productive operator. Massey Ferguson designers and engineers know that this holds true whatever the operation in hand. This is the reason why the sheer brute force of the MF 8700 deserves an award winning cab suspension system.

OptiRide Plus, available on the superb MF 8700, provides unprecedented levels of operator comfort and acknowledges Massey Ferguson's long-held position at the forefront of agricultural innovation.



OptiRide Plus is a dynamic cab suspension system that continually adjusts to a wide variety of driving conditions, using multiple on-board sensors.

Intelligent comfort

The cab sits on four hydraulic dampers that provide the suspension. Sensors automatically register the degree of cab tilt and raise the hydraulics to restore equilibrium. Included in the design is a torsion bar linking the left and right sides of the rear of the cab. This performs an anti-roll function to reduce lateral movement.

The OptiRide Plus cab suspension system processes information, via a series of sensors, from a variety of tractor functions – acceleration, braking, forward/reverse shuttling, etc. – and the control box adjusts the damper units to counter their effects for the smoothest possible ride.

As the 'nerve centre' of the entire system, the electronic control box calculates the optimum damper settings using information from the on-board sensors and the tractor's CAN-bus system.

For the ultimate in cab comfort, the OptiRide Plus system offers the ability to further refine ride firmness/softness during operation. This innovative technology could not be simpler to adjust, using the straightforward switch on pillar pad. This, in turn, minimises the often wearing effects of working on uneven terrain, sudden braking and surges in acceleration so the operator suffers less fatigue, fewer aches and lower stress levels, allowing fresher, more alert work performance.



- 01 In-cab controls
- 02 Transmission lever
- 03 Speedometer
- 04 Brakes
- 05 Accelerator
- 06 Front axle position sensor
- 07 Suspension damper units
- 08 Anti-roll bar
- 09 Control box

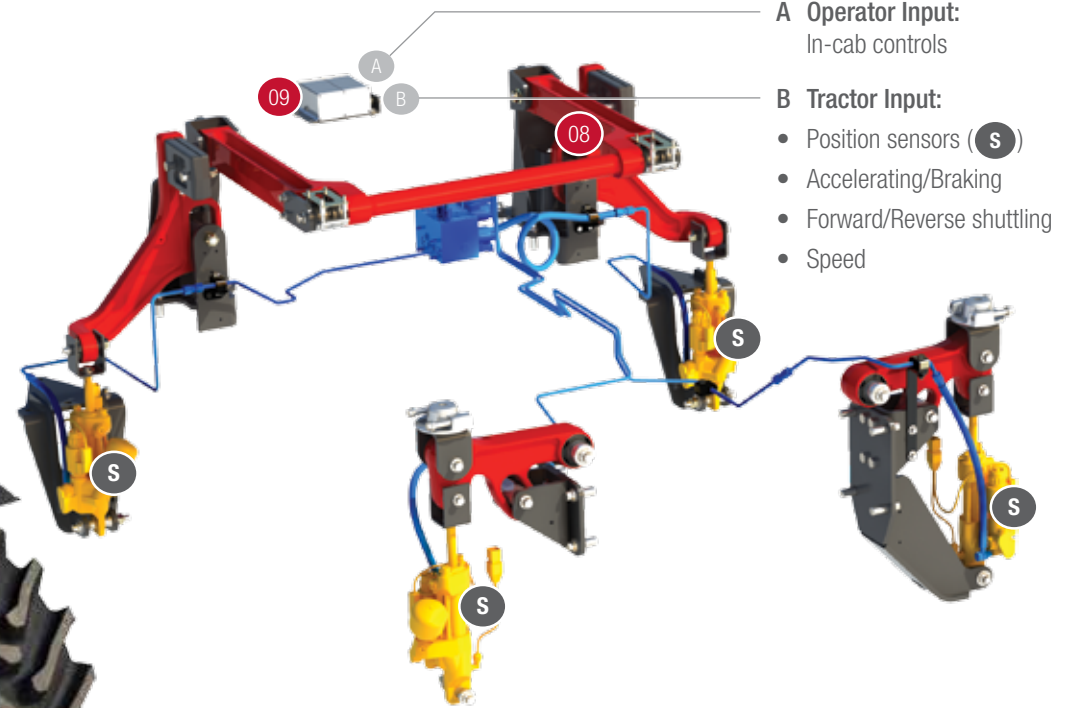

A Operator Input:
In-cab controls

B Tractor Input:

- Position sensors (S)
- Accelerating/Braking
- Forward/Reverse shuttling
- Speed

MF 8700

The new dimension in traction:

ultimate performance in all conditions



Tractor power means nothing if it cannot be transferred to where it matters: the ground. While we have developed one of the highest powered conventional tractors on the market, we've also put a great deal of research into ensuring that power is useable.

A wide range of ballast and tyre choices, included a large rear wheel diameter of 2.15m, ensures that MF 8700 tractors can be tailored precisely to the tasks that are expected of them, for maximum traction with the minimum of soil damage, whilst using the minimum of fuel. That is part of our commitment to help protect the soil and preserve the land for future generations.

MF8700

Highlights

Increased traction and low soil compaction can be achieved working with the right ballast and tyre choice including tyre pressure.

The right balance between ballasts and tyre choices brings:

- More power to the ground
- Ultimate traction capabilities
- Limited soil compaction to boost yields whilst maintaining soil health for the next generation
- Improved fuel economy



The latest tyre equipment allows MF 8700 models to work at very low tyre pressures, even for high traction jobs, including dual wheels:

- Rear tyre choice up to 900 mm and 2.15 m diameter



A wide choice of ballasts are available

Sometimes you need extra weight to deal with intensive traction work. The MF 8700 is available from factory or via AGCO Parts with additional front, rear and tyre weights to exactly match your needs. This offer includes a new design of 1500 kg and 2300 kg compatible with weight extension, wheel weight installation from 250 to 750 kg on each side and integrated belly weight from factory.

Best in class 400hp manoeuvrability...



Curved chassis and integrated front linkage smart designs provide excellent manoeuvrability and tight turning angles.



Smart and easy system to pass from front linkage working position to stowage position for minimizing overall tractor length when front linkage isn't needed such as transport application





Four-wheel drive and differential lock

The transmission controller also relieves the driver of many repetitive tasks of four-wheel drive and differential lock operation. It engages the differential lock when it's required, when the implement is lowered into work, and disengages it when it's not:

- Automatic disengagement of 4WD and differential lock above 14 km/h
- Automatic differential lock disengagement when a rear linkage mounted implement is raised (and re-engagement when lowered)
- Automatic differential lock disengagement when either one or both of the brake pedals are pressed (and re-engagement when released)
- Automatic 4WD engagement when both brake pedals are depressed, when the differential lock is engaged or the handbrake applied
- Automatic differential lock and 4 WD disengagement linked to wheels turning angle

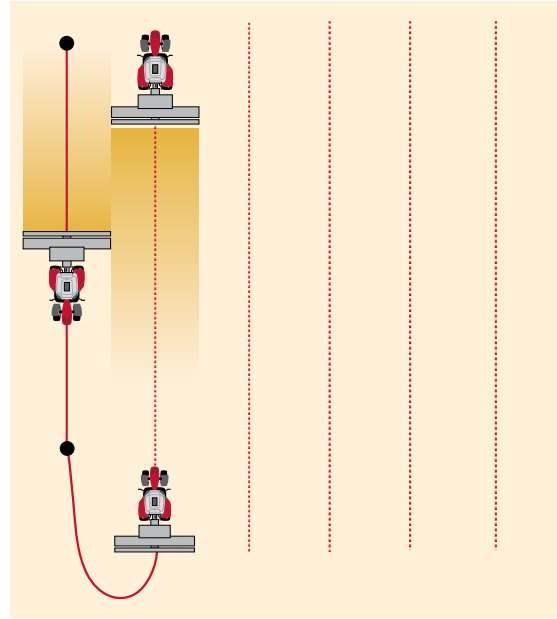

SpeedSteer – for precision and reduced effort

SpeedSteer allows the operator to adjust the steering ratio and select the number of steering wheel turns required for a given amount of steering angle. The system, which can be switched on and off, automatically disengages above 18km/h for safe operation at high speed, whether in the field or on the road (optional on Efficient version and standard on Exclusive)

QuadLink suspended front axle

Standard on all MF 8700 tractors, QuadLink front suspension provides a smooth ride, improved traction, excellent ground clearance and tight turning angles, even on tractors with large tyres.

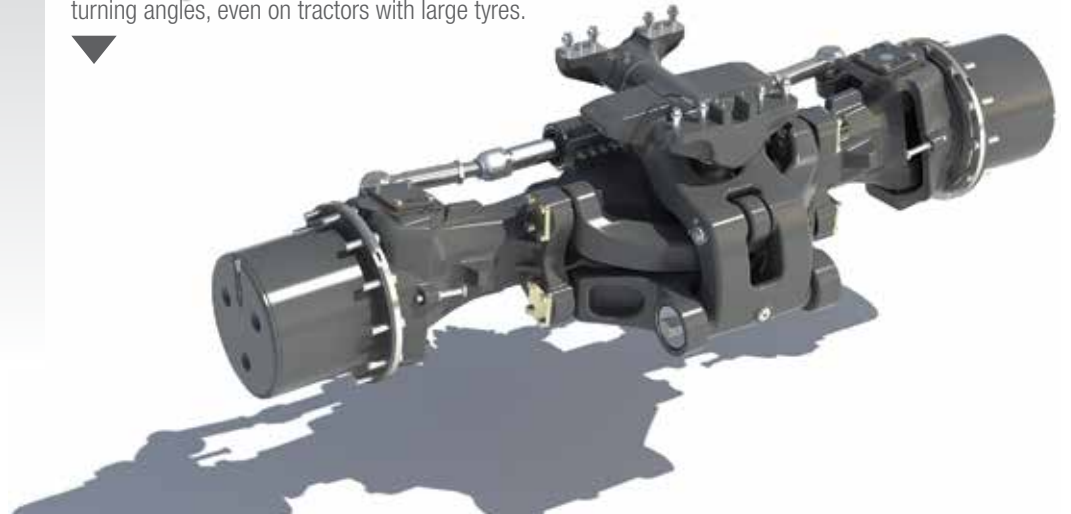

Powerful Hydraulic Muscle:

give a lift to your productivity

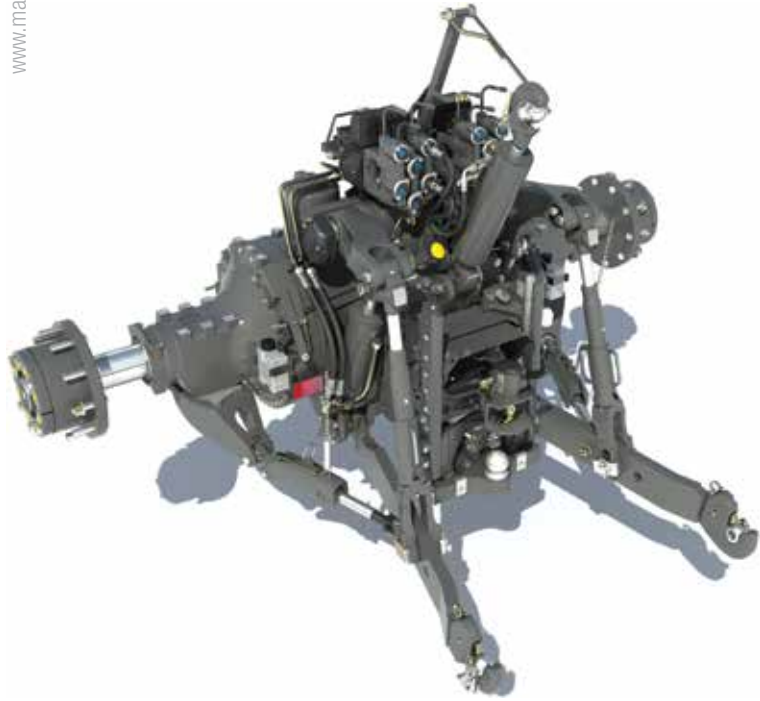

The innovator of three-point linkage power and hydraulic capability, Massey Ferguson has never rested on its laurels when it comes to ensuring its systems meet and exceed the requirements of modern machinery. Part of Massey Ferguson DNA, our three-point linkage is the finest example of productivity, power and responsiveness for the operator in the field for more than 75 years.

Heavy-duty front and rear linkages

With a rear linkage lift capacity of 12,000 kg, there are few tractors in this power bracket that can match the MF 8700 series for the ability to hoist heavy implements. The rear linkage design and the tractor's structural build are designed to handle such demands, with twin external lift rams and twin variable-float telescopic stabilisers. Quick couplers with decompressing system are standard, as external linkage and valve controls. A total of 6 spool valves is available.

At the front, buyers can specify a fully-integrated 5,000 kg front linkage designed to match the Massey Ferguson front suspension, with two double-acting spool valves and a free return line.

Rear Hitch

The rear hitch with a choice of pintle pin, pick-up hitch, clevis, K80 ball or drawbar has been completely redesigned to make coupling quicker, easier and safer. The ISO hitch design is compatible with a wide range of clevis and drawbar alternatives according to markets.

The ultimate in draft control accuracy

Massey Ferguson continue to lead the way in electronic linkage control (ELC). On MF 8700 tractors, the latest evolution in this development provides even greater accuracy in depth setting and ground contour following to provide excellent weight transfer, traction and workrates, while reducing wheelslip, tyre wear and fuel consumption. Armrest-mounted controls for functions including quick engagement, sensitivity and raise/drop speed fall intuitively to hand. There are also full rear fender controls on both sides of the tractor to help when hitching up.



Powerful braking systems

As you would expect from a tractor of this size, designed to haul and handle the heaviest loads, the MF 8700 braking system is as beefy as the rest of its hydraulic arrangement. Reassuring, fade-free braking comes courtesy of oil-immersed, power-assisted disc brakes, while air brakes for trailed equipment are an option.



Standard Active Transport Control

Designed to minimise the pitching action of heavy mounted equipment when in the raised position during transport or on the field headland, Active Transport Control, fitted as standard to MF 8700 tractors, is a shock-absorbing system that is automatically adjusted for different implement weights to counter implement bounce. The result is smoother, safer, faster transport and a reduced risk of damage to the tractor and its hydraulic system.

ATC and Quadlink

The combination of ATC and the Quadlink suspended front axle provides exceptional stability when transporting or operating mounted equipment at speed, resulting in greater comfort and safety for the driver, and ultimately greater productivity.

Power Beyond

Built into the CCLS spool block is a Power Beyond facility that, via additional flow and return pipes, provides oil flow directly from the pump, enabling additional remote spool valves to be connected.

Auxiliary spool valves

Standard specification comprises four electro-hydraulic spool valves, with up to eight available if required. Fingertip Spool Management allows complex equipment to be precisely and easily controlled. There are separate spools for the operation of the front linkage and front couplers, as well as the optional pick-up hitch.

High flow, high pressure oil

All MF 8700 tractors feature a closed centre load-sensing (CCLS) hydraulic system that provides 205 l/min of oil flow for both linkage and external services, for fast response whatever the load. The result: the ultimate in fuel and power efficiency. Decompression-type hydraulic couplers make implement attachment easier, allowing coupling and uncoupling under pressure.



All rear couplers are equipped with an hydraulic decompressing system.



MF 8700

Performing the most demanding operations with precision

High specification PTO

MF 8700 tractors can be specified with a fully-independent 540 Eco/1000 rpm PTO, or 1000/1000 Eco speeds. External engagement and emergency stop buttons provide convenience and safety. External engagement can be automated with engine speed for fast control of implement such as slurry tank filling.

Economy PTO

Achieved at around 1,600 rpm, 540E and 1,000E rpm economy PTO speeds further improve fuel efficiency and noise levels when on lighter duties.

Automated PTO control

In 'Auto' mode, the PTO is automatically disengaged when travelling at speeds above 25 km/h, while it is also disconnected when the linkage is raised and re-engaged when it is lowered. The transmission controller monitors and controls PTO engagement according to load for a smoother take-up, leading to improved driver comfort whilst protecting both tractor and implement from damage due to inappropriate engagement.

Front PTO

A six-spline front PTO which operates at 1,000 rpm is optional on MF 8700 tractors, and when combined with a front linkage allows a wide range of additional implements to be powered, helping to reduce passes and improve efficiency.

Power with economy

Nominal PTO speeds are achieved at, or near to, 1,950 rpm, which is also maximum engine power. With the benefit of a constant power band of up to 600 rpm and the ability, with Dyna-VT ability, to precisely select any ground speed at the chosen engine speed, you can always achieve a perfect match of PTO speed, forward speed and power, for optimum economy.

Command Centre PTO selector switches and Auto activation button.



Fender mounted PTO, hydraulic spool valve and linkage controls.



Pillar mounted PTO speed selection controls and linkage controls.

Fuse Technologies: joined-up farming

Information is power, with accurate data measurement and recording enabling more precision in decision making. The pace of progress and innovation set by the MF 8700 series is evident in the on-board technology solutions that it incorporates – systems that have a real place in the future of agriculture, helping farmers to become more productive through the knowledge brought by putting precision-measured data at the business owner's fingertips.

Through AGCO FUSE Technologies, Massey Ferguson delivers the straightforward and dependable technology solutions it has long been known for – technology that quietly, without fuss, does the jobs that farmers require of it. The on-board technology solutions incorporated into the MF 8700 series are a clear indication of the pace of progress and innovation set by Massey Ferguson. Information is power where making farming more efficient and productive is concerned. This is why we focus on delivering straightforward, dependable technology solutions that bring about improved productivity, ease of use and profitability through higher yields, lower input costs and greater profits.

FUSE[™]
TECHNOLOGIES





The CCD console:

keeping you informed and in control



1

Full tractor functions management and optimisation features such as transmission, engine and hydraulics. Moreover there is the remarkable Dual Control system providing excellent control of semi-mounted ploughs by automating the furrow entry and exit. At the same time the system adjusts the plough's depth wheel in relation to the rear linkage. The same system is also used to control implements on the front linkage, automating depth settings and the entire operation, in synchronisation with the rear linkage.



2

Video Mode – Pictures from an on-board camera can be displayed on the console screen, allowing operators to monitor complex implements or simply improve safety and efficiency when reversing.



3

ISOBUS for total implement control – ISOBUS allows an implement manufacturer's control system to be displayed on the console screen, saving owners and operators time and money, with no need to install additional terminals in the cab. Simply plug the implement lead into the tractor's ISOBUS socket and the system automatically uploads the operating menus and displays on the screen – implement control switch assignment on Multipad available (Exclusive version only).





4

Auto-Guide™ 3000 auto-steering guidance operation can be displayed through the CCD rather than through a separate screen, providing the driver with enhanced visibility. Thanks to this integration, no additional wires are needed – refer to p.42 guidance section to find out more about the most easy-to-use guidance system available in the market today.



5

Memorise data and settings – Up to eight different memories enable the system to record information during operation on area worked, fuel use, hours worked and much more. All the settings and parameters can be stored by the CCD. Securely back-up those tractor settings: A truly unique feature of CCD is the ability to save the memorised tractor settings to a USB memory stick and manage those settings before commencing work. All these settings can be transferred between all your machines equipped with CCD.



6

Headland management settings – The CCD Console comes as standard with the most intuitive, straightforward and easy-to-use automatic headland management system available in the market today and developed exclusively by Massey Ferguson. It is designed to save you significant time at headlands, allowing you to concentrate on the operation in hand so that you can maximise outputs with ease.



Straightforward and intuitive technology from Massey Ferguson



Guidance options to keep you on track for profit



With guidance systems having been proven to save up to 12% fuel in field operations, more and more farmers are considering the benefits of investing in guidance and auto-steering. Auto-Guide™ 3000 is a hands-free steering system that is capable of delivering sub-metre, decimetre and centimetre accuracy.

An Auto-Guide™ 3000 TopDock receiver comes factory-fitted as an option to Efficient and Exclusive MF 8700 tractors. This allows the use of the free sub-metre accuracy EGNOS correction signal. Upgrades are made easily, without unlocking code, by only adding a snap-in module to the base of the TopDock. An inertial measurement unit (IMU) can be installed to improve tractor positioning where greater accuracy is required, with a radio snap-in providing the ultimate in precision.



Datatronic CCD console

Auto-Guide™ 3000 can be displayed through the Datatronic CCD for those who need a simple and integrated guidance terminal, rather than through a separate screen, this allows increased visibility for the driver.



C3000 console

The C3000 offers advanced capabilities and allows you to achieve more. It's the ideal solution for anyone wanting to keep a constant record of jobs and tasks. C3000 allows you to create fields to measure the total area, store and export all the data collected. You can recall this vital information for future tasks. The C3000 interface is straightforward to operate and easy to navigate around with simple menu structures. It has a 12.1" colour, touch screen for easy recognition plus an excellent view of fields and applications. The touch screen allows for quick menu selection and general operation and can be split into 3 smaller screens for more efficient monitoring of tasks.

GO MODE FUNCTION

A Go mode function allows the operator to begin working with auto-guidance/steering for the first time within a five-minute set-up time, making the system easy to work with and the benefits faster to reap. This is the easiest way to start auto-guidance without going into any settings, and suits those looking for a simple system to use that does not require advanced settings.

This unique function allows Auto-Guide™ 3000 start-up within 5 minutes to allow even inexperienced drivers to step seamlessly into working with the system after just a few implement and wayline settings.

Implement



Wayline



Go!



Accuracy	30 cm	20 cm - 5 cm	2 cm
Correction signal	EGNOS* OmniSTAR VBS	OmniSTAR VBS/HP OmniSTAR G2	RTK Base station NTrip
Receiver	Auto-Guide™ 3000 TopDock	Auto-Guide™ 3000 TopDock with IMU	Auto-Guide™ 3000 TopDock with IMU and Radio snap-in
Applications	Spraying/spreading Harvesting Cultivation Mapping	Spraying/spreading Harvesting Cultivation Mapping	Seeding/planting Strip tillage Weeding

MF 8700

Your finger on the pulse at all times: introducing AGCOMMAND™

Large farms and contractors who want a clearer idea of how their machinery is performing will welcome the consistent, concise and accurate information provided by the AGCOMMAND™ telemetry system.

AGCOMMAND™ allows machinery owners and managers to monitor vehicle position, performance, history and status, as well as operating costs, all with the aim of enhancing productivity. Every ten seconds the AGCOMMAND™ system identifies the GPS location of a machine and reports its performance. This is transferred to a central server, from where it can be accessed over the internet from your farm computer.

The AGCOMMAND™ App allows on-the-go access to the system so that you can monitor machinery wherever you are and whenever you want. You can also use the history and report function to run analysis on the field. The AGCOMMAND™ App is available for iPads and iPhones. It has all the same functions of the usual AGCOMMAND™ system, and capabilities include near-real time access to the machine, with a home page that supplies fast information and a quick overview of machine data like position, address and weather conditions.

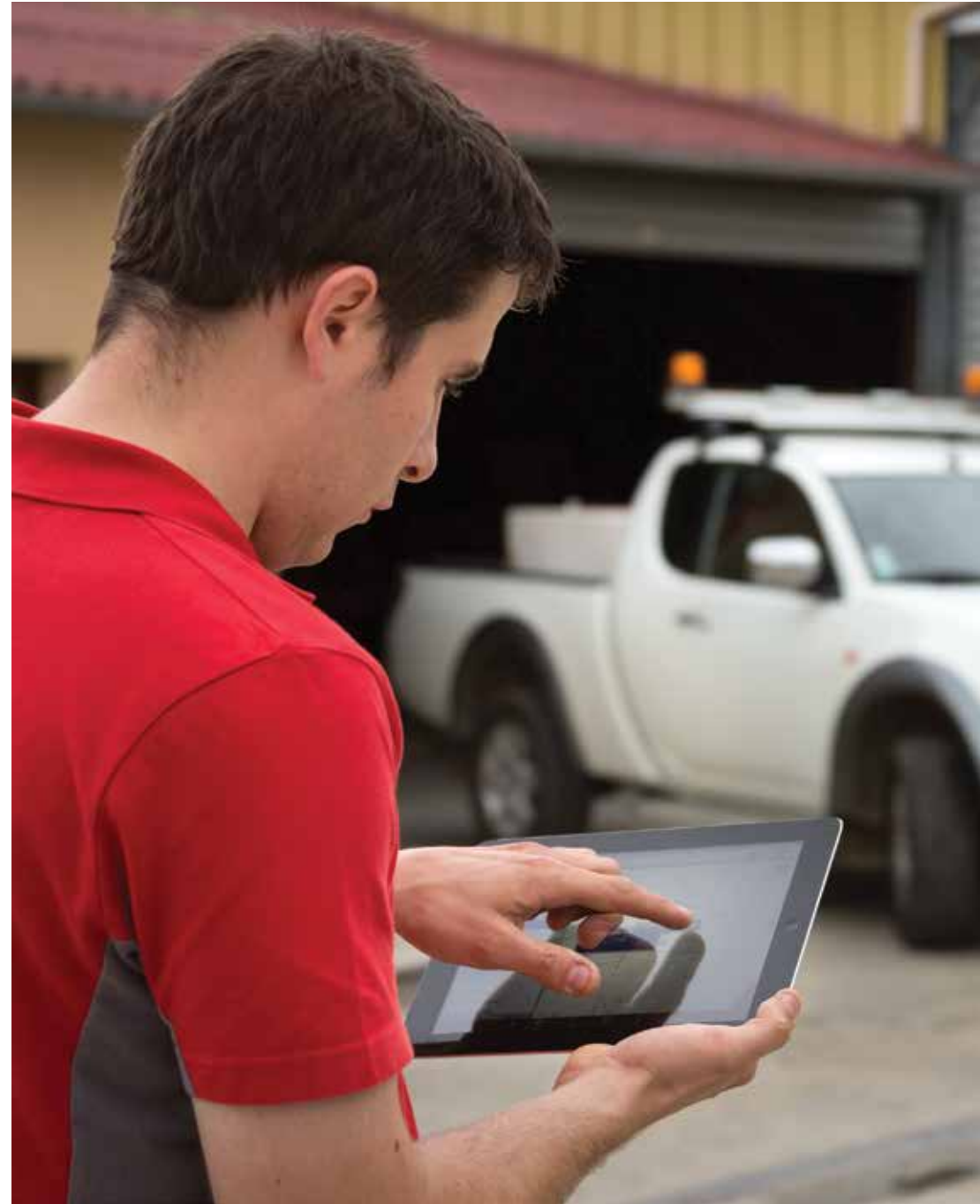



Vehicle history maps: Show where the tractor has been during a selected time period, making it possible to view where the tractor stopped, and where it was working and travelling from and to, via a Google plan or satellite view. AGCOMMAND™ Advanced can show data collected via the machine's CANBUS system, such as engine load, wheelslip and fuel consumption. And it offers the ultimate in machine traceability.



Efficiency reports: These can be created in two ways – as time efficiency reports based on a percentage of the total engine hours of each status, or as distance efficiency reports based on the percentage of working/headland/transport elements of the total distance travelled by the machine. They show the time the machine was working and/or on the headland, in transport mode, and stationary. This makes it possible to quickly analyse the efficiency and ability of operators. The report can be made for up to five machines at a time, and the data can be exported into manageable PDF or Excel files to be worked on via PC or laptop.

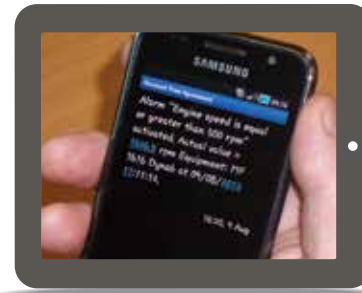

Text message alerts: These allow owners to be alerted via a mobile phone if their machine should enter or leave a predefined area created on the Geofence website. It can also, for example, send a message to alert the owner or manager when an operator is returning to the farm or if he requires fuel in the field. AGCOMMAND™ Advanced, meanwhile, allows the setting of alarms on CAN parameters, and service alarms can be added to the system, to alert the owner and/or dealer.



Dashboard: AGCOMMAND™ Advanced allows users to view machines for up to 30mins/day in near real time. The main parameters available through the virtual dashboard can be viewed via a PC or laptop. If fuel consumption appears too high or it appears that settings need adjusting to improve output, operators can be alerted directly through the AGCOMMAND™ Dashboard in addition to a text message alarm on his mobile phone. When working with combines, users can view sieve and concave position, rotor speed, forward speed, productivity, output and grain loss, while parameters can be set to achieve the highest efficiency. AGCOMMAND™ Advanced can ensure that even inexperienced combine operators get the best from their machines, and can be used to monitor simultaneously several combines in the same field.



Scan me to get the app!



AGCOMMAND™ telemetry has a broad range of further uses that make the most of the information it collates. These include the production of historic maps to show a machine's activity, machine and operator comparisons, the production of reports ranging from those on individual fields to full season efficiency analyses that allow productivity to be studied and maximised. For those who wish to glean the ultimate in accurate numbers, the AGCOMMAND™ Advanced upgrade records operating and performance data even more regularly – every ten seconds – than the standard system.

And now... Get on-the-go flexibility with the new AGCOMMAND™ App and take the office to the field.

AGCOMMAND™



Lifetime from Massey Ferguson:

no matter where life or work takes you, we'll be there

The Massey Ferguson distributor and dealer network ensures every machine comes with the support and service you need to keep working – whenever and wherever you need it.

Our dealers are committed to finding the right product for you and then supporting you with the best services, parts provision and back-up. Behind every Massey Ferguson machine is a family of highly skilled specialists who are dedicated to supporting you, your equipment and your business.

Ask your dealer about our finance plans, which can include leasing, hire purchase, contract hire and loan facilities.

manager provides total peace of mind

manager Service and Extended Warranty Plan* is a comprehensive, industry-leading package that provides total care of your tractor providing routine maintenance, repairs and a full AGCO-backed warranty, which includes:

- Engine and transmission
- Hydraulics
- PTO
- Steering
- Electronics
- Cab and controls
- Axles

Regular servicing in the manager plan provides 'preventive maintenance' – picking up any faults before they become a problem, which helps reduce downtime. A full dealer service history, using genuine AGCO Parts will also increase the residual value of the machine.







No hidden costs:

All-Inclusive from Massey Ferguson – a new generation of full service*

Massey Ferguson is the only brand which can offer you a full service package for your new MF 8700 tractor including:

YOUR TRACTOR +

YOUR FINANCING +

**YOUR REPAIR AND
MAINTENANCE MANAGER CONTRACT**

For your individual quotation, contact your local MF dealer!

So you'll know exactly your cost of ownership with no hidden agenda, no extra expenses for up to 5 years and 6000 hours in the UK and Ireland.

At the end of the contract, the choice will be yours:

1. Get another brand new Massey Ferguson tractor so you are sure you are using the latest onboard technologies
2. Return the tractor to your local MF Dealer!

This is specially designed to meet the needs of UK and Irish farmers. This scheme insures you will benefit from superior innovation in the machinery industry that will secure your profitability. Similar offers are available in France and Germany.

In summary you will:

- Know the cost of ownership from day 1:
Ensuring it is easy to budget and there are no surprises
- Benefit from the very latest technology on your tractor

Don't hesitate to discuss with your local Massey Ferguson dealer or your AGCO Finance specialist. They will be able to provide you with a tailored solution to help grow your business.

* only applicable on MF 8700 Series and only available in UK & Ireland, France and Germany. Please contact your AGCO Finance specialist and your local dealer to check availability in your area. Terms and conditions apply that might vary according the market.

WANT TO KNOW THE COST PER HOUR OF THIS MF 8732 DYNA-VT?



Servicing made easy: simple and straightforward

With a Massey Ferguson MF 8700 series tractor, time spent in the yard preparing for the day ahead is kept to a minimum. We have combined practicality with style to ensure daily maintenance is speedy, straightforward and simple, taking the stress out of maintaining your tractor, getting you to the field earlier for greater productivity.

And it's not just about time spent on service – it's about money too. With service intervals having been lengthened by 25% to 500hrs, maintenance costs have been substantially reduced.

Plenty of room to access radiators for cleaning.



The well proportioned cooling package is easy to access, clean and maintain. 90% of dust is removed naturally thanks to the suction from the cooling fan. The engine air filter is also very easy to access and clean.



The single piece bonnet lifts fully to allow excellent access for full servicing.





The cab air filter can be removed easily for cleaning.



The AdBlue® tank has been carefully positioned to improve insulation in high and low temperatures. Filling of both tanks is safe and convenient.



The waisted bonnet and front axle design ensures comfortable access to the engine oil filters and oil dipstick.

Standard and optional equipment – tailor your tractor to you

	Efficient	Exclusive
Engine		
6 cylinder AGCO POWER Stage 4	●	●
Selective Catalytic Reduction (SCR) technology	●	●
EEM Engine with memorised speed control	●	●
Engine Block Heater	○	○
Transmission		
Power Control shuttle	●	●
Right hand shuttle	–	●
T lever on Command Control Armrest	●	–
MultiPad lever on Command Control Armrest	–	●
Dyna-VT 40km/h Super Eco with Dynamic Tractor Management (DTM)	●	●
Dyna-VT 50km/h* Eco with Dynamic Tractor Management (DTM)	○	○
Cruise speed control	●	●
ParkLock	●	●
Operator environment		
Standard Air Conditioning	●	–
Automatic Air Conditioning	○	●
Super Deluxe Air Suspended Dynamic Damping System Seat	●	○
Super Deluxe Air Suspended Maximo Evolution Seat	○	●
Auxiliary Seat with Seatbelt	●	●
Radio – MP3 – SD card slot – USB	●	–
Radio, CD, MP3, Equalizer, Bluetooth, USB & Front Aux.	○	●
Telescopic Large Side Mirrors	●	–
Telescopic Large Side Mirrors with Electric Adjustment and de-icing	○	●
OptiRide Plus Cab Suspension semi-active	○	●
Sunroof	○	●
Radar and slip control	○	●
CCD/Datatronic 4 with video and isobus capability	○	●
Trailer steering axle management	○	●
Dual Control	○	●

	Efficient	Exclusive
Operator environment (cont.)		
Headland Management System	○	●
Auto-Guide™ 3000 with Go Mode	○	●
SpeedSteer	○	●
AGCOMMAND™	○	●
Chassis and hydraulics		
Electrical controls of spool valves	●	●
Electronic Joystick	●	●
Power beyond with couplers	○	●
Loader ready tractor with Multifunction joystick	○	○
Electronic linkage controls with Active Transport Control	●	●
Auto PTO function	●	●
Auto 4-Wheel-Drive and Auto DiffLock functions	●	●
Telescopic stabilisers	●	–
Automatic stabilisers	○	●
Hydraulic Toplink	○	○
Integrated front linkage system	○	●
Integrated Front PTO	○	○
Electrical equipment		
Automatic Isolator switch	●	●
ISO signal connector	●	●
External lift control on fenders	●	●
External PTO start/stop control on fender	●	●
External remote valve control on fender	●	●
Xenon lighting	○	○
Other equipment – specifications may vary by market		
Quadlink – Suspended front axle	●	●
Pivoting front fenders	●	●
Additional heater in cab	○	○
Hydraulic trailer brake	○	○
Pneumatic trailer brake	○	○

KEY

- Not available
- Standard specification
- Optional
- * Depending on market legislation

Specifications as standard

Engine	MF 8727	MF 8730	MF 8732	MF 8735	MF 8737	
Engine Type	AGCO POWER					
No. of cylinders/no. of valves/Capacity	No /no./l					
Bore / Stroke	mm					
Aspiration	2 stage Turbocharger with Interstage Charge Air Cooler and electrical wastegate at the high boost pressure side					
Injection type	Common rail					
Fan type	Vistronic – variable fan speed					
Maximum hp @ 1,950 rpm	✚ ISO hp	270	295	320	350	370
Maximum torque @ 1,500 rpm	✚ Nm	1,220	1,300	1,390	1,530	1,540
Maximum power with EPM	hp	300	325	350	380	400
Maximum torque with EPM	Nm	1,300	1,390	1,500	1,590	1,600
Max. power available @ PTO shaft (OECD, accuracy +/- 3%)	hp	225	250	275	300	320
Fuel tank capacity	litres					
AdBlue® tank capacity	litres					
Service interval	hours					
Transmission Dyna-VT						
Type	Stepless, Continuously variable transmission with Dynamic Tractor Management (DTM)					
Field speed range	km/h	0,03 - 28 km/h Forward and 0,03 - 16 km/h Reverse				
Road speed range	km/h	0,03 - 50 km/h* Forward and 0,03 - 38 km/h Reverse 40 km/h Eco at 1400rpm - 50km/h* Eco at 1550rpm				
Rear Linkage and hydraulics						
Lower links type	Category	3 or 4				
Maximum lift capacity, at link end	kg	12,000				
Hydraulic type	Closed Centre Load Sensing					
Maximum Flow	litres/minute	205				
Maximum pressure	Bars	200				
Maximum no of rear spool valves	6					
Front linkage and Front Power Take-Off						
Type	Integrated on chassis with independent valve control, electro-hydraulic control					
Lower links type	Category	3				

Front linkage and Front Power Take-Off (cont.)	MF 8727	MF 8730	MF 8732	MF 8735	MF 8737
Maximum lift capacity, at link end	kg		5,000		
Maximum No of front spool valves		2	2	2	2
Engine speed at 1000 front PTO speed	rpm		2,036		
Power Take-Off (Rear)					
Operation and control	Electro-hydraulic engaged. Start/stop control on armrest and on rear fender, with headland automation				
Speed selection	Electro-hydraulic control in cab				
Engine speed at 540Eco / 1000	rpm		1,577 / 1,970		
Engine speed at 1000 / 1000Eco	rpm		1,970 / 1,605		
Shaft diameter	inches	1 3/8 " 6 & 21 splines; 1 3/4" 20 splines			
Wheels and Tyres (Full range available. Please consult your Dealer)					
Front	600/65R34				
Rear	710/75R42				
Weights					
Average minimum weight with no ballast	kg	10,800			
Maximum Gross vehicle weight	kg	18,000			

KEY

- ✱ ISO TR14396
- Not available
- * Depending on market legislation

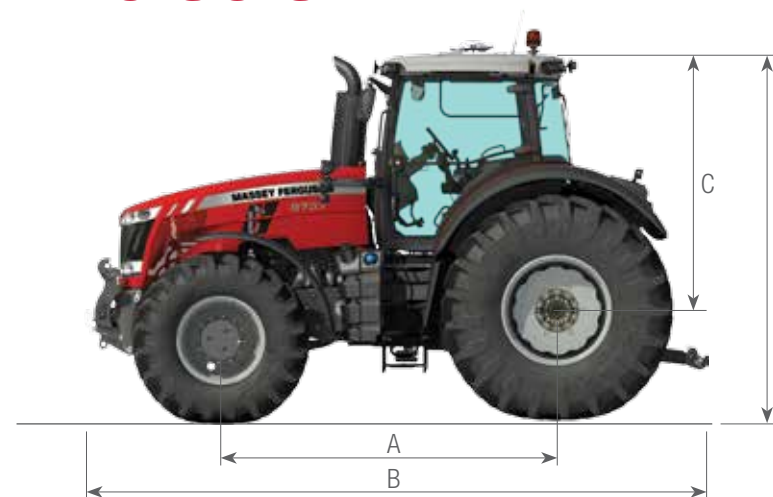
Dimensions

	MF 8700
A – Wheelbase – mm	3,093
B – Overall length from front weight frame to rear linkage arms – mm	5,552
B – Overall length from front linkage to rear linkage arms – mm	6,200
C – Height at centre of rear axle to top of cab – mm	2,353
D – Total height on top of the roof – mm	3,428



MASSEY FERGUSON

A world of experience. Working with you.



<http://www.facebook.com/MasseyFergusonGlobal>

twitter.com/AGCOcorp

<http://www.youtube.com/MasseyFergusonVideo>

blog.agcocorp.com



MASSEY FERGUSON is a worldwide brand of AGCO.
© AGCO Limited, 2013 | 15502/1013 | A-English/1013/3m



Responsible forest management

